

SPECIFICATION & DETAILS

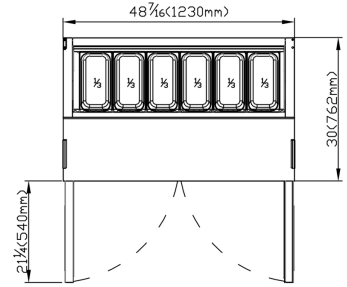

© PUR-48D2

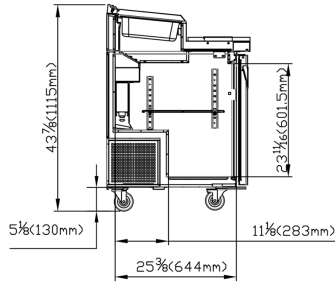
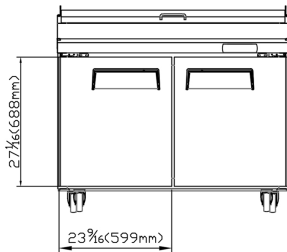
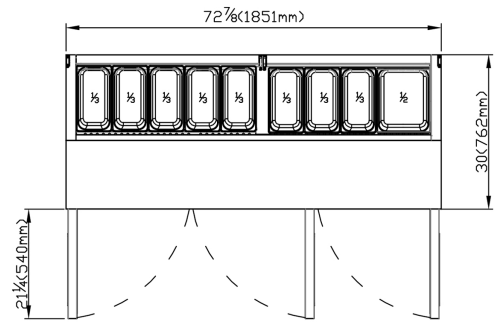
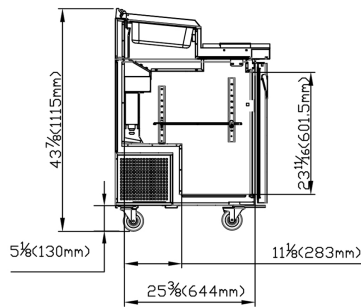
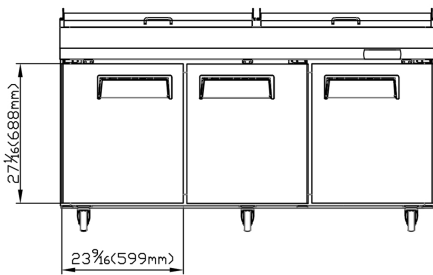

© PUR-72D3

Model No.	Net Capacity	Unit Dimensions W x D X H	Packaging Dimensions W x D X H	Voltage Frequency	Temp. Range	Refrigerant	40'HC QTY
PUR-28D1	6.8 Cu. Ft.	27 11/16" x 30" x 43 7/8"	30 7/16" x 32 11/16" x 45 11/16"	115V / 60Hz	33°F ~ 39°F	R290	86
PUR-36D2	8.3 Cu.Ft	36 9/16" x 30" x 43 7/8"	39 5/16" x 32 11/16" x 45 11/16"	115V / 60Hz	33°F ~ 39°F	R290	67
PUR-48D2	12.2 Cu.Ft	48 7/16" x 30" x 43 7/8"	51 3/16" x 32 11/16" x 45 11/16"	115V / 60Hz	33°F ~ 39°F	R290	52
PUR-60D2	17.0Cu.Ft	60 7/16" x 30" x 43 7/8"	63 3/16" x 32 11/16" x 45 11/16"	115V / 60Hz	33°F ~ 39°F	R290	42
PUR-72D3	18.8 Cu.Ft	72 7/8" x 30" x 43 7/8"	75 5/8" x 32 11/16" x 45 11/16"	115V / 60Hz	33°F ~ 39°F	R290	35

© NOTE: SINOWER RESERVES THE RIGHT TO CHANGE SPECIFICATIONS WITHOUT NOTICE

SPECIFICATION & DETAILS

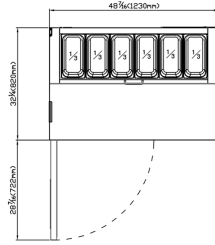
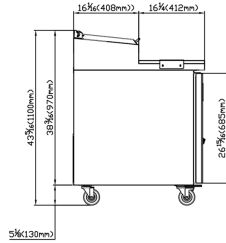
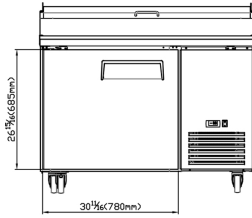

© PUR-44D1

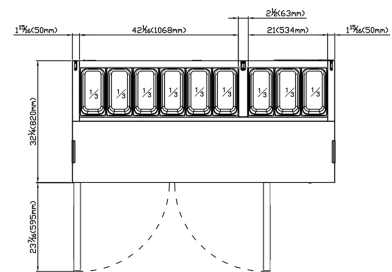
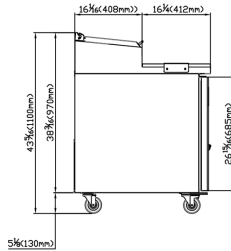

© PUR-67D2

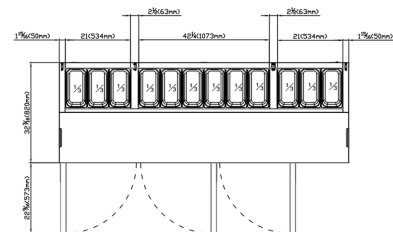
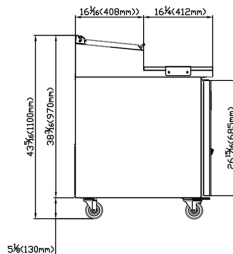
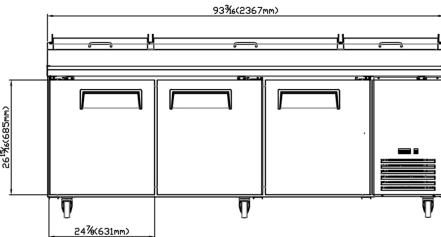

© PUR-93D3

Model No.	Net Capacity	Unit Dimensions W x D X H	Packaging Dimensions W x D X H	Voltage Frequency	Temp. Range	Refrigerant	40'HC QTY
PUR-44D1	12.9 Cu.Ft	48 7/16" × 32 5/16" × 43 5/16"	51 3/16" × 35 1/16" × 46 1/16"	115V / 60Hz	33°F ~ 39°F	R290	48
PUR-67D2	17.7 Cu.Ft	69 1/2" × 32 5/16" × 43 5/16"	72 1/4" × 35 1/16" × 46 1/16"	115V / 60Hz	33°F ~ 39°F	R290	34
PUR-93D3	31.1 Cu.Ft	93 3/16" × 32 5/16" × 43 5/16"	96" × 35 1/16" × 46 1/16"	115V / 60Hz	33°F ~ 39°F	R290	25

© NOTE: SINOWER RESERVES THE RIGHT TO CHANGE SPECIFICATIONS WITHOUT NOTICE